

ViPlex Handy

LAN-Based Screen Management Software



User Guide

Product Version: 1.2.7

Document Number: NS120100284

Copyright © 2018 Xi'an NovaStar Tech Co., Ltd. All Rights Reserved.

No part of this document may be copied, reproduced, extracted or transmitted in any form or by any means without the prior written consent of Xi'an NovaStar Tech Co., Ltd.

Trademark

 is a registered trademark of Xi'an NovaStar Tech Co., Ltd.

Statement

You are welcome to use the product of Xi'an NovaStar Tech Co., Ltd. (hereinafter referred to as NovaStar). This document is intended to help you understand and use the product. For accuracy and reliability, NovaStar may make improvements and/or changes to this document at any time and without notice. Any problem in use or any good suggestion, please contact us through ways provided in the document. We will do our utmost to solve the problems and adopt the suggestions after evaluation as soon as possible.

XI'AN NOVASTAR TECH CO.,LTD

Change History

Android

Version	Release Date	Description
V1.2.7	2018-07-31	<ul style="list-style-type: none"> Multi-screen mosaic can be quickly configured. Images can be cropped while you add them.
V1.2.0	2018-01-22	<ul style="list-style-type: none"> The UI was optimized. The quick subsection function of the brightness parameters was modified. Verification rules for the terminal password were modified. The solution editing function was modified.
V1.1.0	2018-01-03	<ul style="list-style-type: none"> Screen Information was added in Screen Management. In Playback Management, vnox was modified to Cloud Solution and program was modified to LAN Solution. In Remote Management, Player binding was modified to VNNOX and Remote Monitor was modified to NovaiCare. In Monitoring > System Parameter, CPU temperature was removed. Under Screen Management, the Screen Configuration function was removed.
V1.0.0	2017-07-20	First release

iOS

Version	Release Date	Description
V1.2.7	2018-07-31	<ul style="list-style-type: none"> Multi-screen mosaic can be quickly configured. Images can be cropped while you add them. Supports iPad.
V1.2.0	2018-01-22	<ul style="list-style-type: none"> The UI was optimized. The quick subsection function of the brightness parameters was modified. Verification rules for the terminal password were modified.

Version	Release Date	Description
		<ul style="list-style-type: none"> • The solution editing function was modified.
V1.1.0	2018-01-03	<ul style="list-style-type: none"> • In Screen Settings, RV Card Configuration was added. • Text, Analog Clock and Digital Clock were added in Solution List. • In Playback Management, vnox was modified to Cloud Solution and program was modified to LAN Solution. • In Remote Management, Player Binding was modified to VNNOX and Remote Monitor was modified to NovaiCare. • In Monitoring > System Parameter, CPU Temperature was removed. • In Screen Management, the Screen configuration function was removed. • In Settings, Message was removed.
V1.0.0	2017-07-20	First release

Contents

Change History	ii
Contents	iv
1 ViPlex Handy Introduction	1
2 Download and Installation	2
3 Taurus Login	3
4 Function Description	5
4.1 Screen Management	5
4.2 Multi-Screen Mosaic	9
4.3 Solution List	11
4.4 Settings	11
4.5 Media	12
5 FAQ	13
5.1 Viewing the Version of ViPlex Handy	13
5.2 Viewing the Version of the Taurus.....	13
5.3 Upgrading the Version of the Taurus.....	13

1 ViPlex Handy Introduction

ViPlex Handy is a software for managing screens via LAN. The software can be used for the management of the Taurus series players. ViPlex Handy supports Android and iOS.

Advantages of ViPlex Handy:

- Friendly user interface. UI design takes full account of the habits of users.
- Easy to use. The Taurus can be wirelessly connected and easily accessed.
- Synchronous playback, which is capable of playing the same content on different screens synchronously.
- Smart brightness adjustment, which is capable of setting automatic and timed brightness adjustment.
- Dual WiFi functionality, which is capable of setting WiFi AP mode and WiFi Sta mode.
- 4G connection, which is capable of setting mobile data network of the Taurus with 4G module.
- Dual-mode (synchronous and asynchronous), which is capable of setting video output mode.
- Adaptive display, which is capable of displaying pictures automatically according to screen size.
- Terminal binding, which can easily bind the Taurus with cloud-based publishing system VNNOX and cloud-based monitoring system NovaiCare.

2 Download and Installation

Downloading Installation Package

Scan the QR code below using a phone to download the installation package of ViPlex Handy.



Installing Software

Installation of ViPlex Handy is the same as other applications.

3 Taurus Login

Required Information

Please get actual values of the information in [Table 3-1](#).

Table 3-1 Required information



Item	Account Name	Default Password
Connect Taurus WiFi AP	AP+ last 8 digits of the SN For example: AP10000033	12345678
Connect external router (WiFi Sta mode)	N/A	N/A
Log into Taurus	admin	123456

Operating Steps

Step 1 Connect WiFi AP of the Taurus series products or external router.

Step 2 Start ViPlex Handy.

System can automatically detect the Taurus series products and refresh **Screen List**. Users can also slide down **Screen List** to manually refresh the list.

- : denotes that Taurus is online and you can log into it.
- : denotes that Taurus is offline and you cannot log into it.
- : denotes that Taurus login is successful.

Step 3 Click **Connect** behind the screen name.

Step 4 Enter username and password, and click **Log In**.

The system saves the relevant user name and password of current screen automatically after successful login.

Related Operation

After the system saves the user name and password, users can do the following while logging in Taurus.

- **Connect**: Click to log in Taurus.
- **Forget**: Delete the user name and password of current screen.

- **Delete:** Delete current screen from the screen list.

XI'AN NOVASTAR TECH CO.,LTD

4 Function Description



4.1 Screen Management

Menu	Sub-Menu	Description
Quick Control	Sync Time	Setting UTC time.
	Adjust Volume	Setting volume.
	Color Temperature	Setting color temperature.
Screen Settings	Screen status control	<p>Setting the rules for manual and timed screen on or off.</p> <ul style="list-style-type: none"> • Manual: Switching on or off a screen manually. • Timed: Switching on or off a screen automatically as required.
	Brightness Control	<p>Adjusting brightness manually and setting the rules for automatic and timed brightness adjustment.</p> <ul style="list-style-type: none"> • Manual: Adjusting brightness manually. • Smart: Setting the rules for automatic and scheduled brightness adjustment. <p>In smart brightness adjustment mode, if Auto adjustment is selected, you need to set Auto adjustment parameters, that is, screen brightness will be adjusted according to the auto brightness adjustment parameters during the scheduled enabling time.</p> <p>Select Timing adjust and set the brightness to a fixed value. Screen brightness will be set to the fixed value during the scheduled opening time.</p> <p>Auto brightness adjustment parameters: Divide the environment brightness range from the maximum value to the minimum value into several equal intervals and set the relevant screen brightness of each interval. Select Auto adjustment and the screen brightness will be adjusted automatically according to</p>

Menu	Sub-Menu	Description
		current ambient brightness.
	RV Card Configuration	Sending receiving card configuration file with the extension .rcfgx to the Taurus. Save configuration file to mobile phone before sending the file. ViPlex Handy can automatically identify the configuration file and display it on RV Card Configuration page.
	Timed Restart	Setting the rules for timed screen reboot.
Advanced Settings	Change Password	Changing the login password of the Taurus. The default user name is " admin " and the default password is " 123456 ". We recommend you change the default password after first login.
	Upgrade (Android only)	Upgrading software of the Taurus, including terminal software and terminal system. The terminal software includes terminal application software and FPGA program. Save software upgrade package to mobile phone before upgrading the software. ViPlex Handy can automatically identify the software upgrade package and display it on the Upgrade page.
	Time Synchronization	Setting the rules for time synchronization. To enable synchronous playing on different Taurus units, keeping the time in sync is one of the basic conditions. Users can choose following ways to sync time according to actual situation: <ul style="list-style-type: none"> • Close: Do not sync time. • NTP: After accessing Taurus to the Internet, sync time according to the NTP server of the Internet. Click Time Parameter and set the NTP server address. • RF: Sync the time of Taurus via synchronization module. Click Time Parameter. Set the current Taurus as the master device and enable Auto Time Synchronization to sync the time of the master device with the NTP server. If the current Taurus is set as the slave device, the time of the slave device will be synchronized with the master device via RF network. Time parameters of RF: <ul style="list-style-type: none"> • Group ID: It is required to enter the same group ID for the Taurus units requiring time synchronization, namely, assign these

Menu	Sub-Menu	Description
		<p>Taurus units to the same group.</p> <ul style="list-style-type: none"> • Device Type: Set current Taurus unit as master or slave device. Sync the time of slave device with master device via RF. • Auto Time Synchronization: To sync the time of master device via NTP server, it is required to enable Auto Time Synchronization and set the NTP server address. • NTP Time Server Address: The time of master device will be synchronized based on NTP server.
	Advanced Function	<ul style="list-style-type: none"> • Synchronous Playing: Turning on or off the Synchronous Playing function. When the function is turned on, synchronous displays of different screens can be enabled as long as such screens have the synchronous time and are playing the same contents. • Resolution: Setting the resolution of screen. • Reboot: Rebooting Taurus. • Clear All Media: Clearing all the media stored in the Taurus. • Restore Factory Settings: Resetting the Taurus to factory settings.
Network Settings	Wi-Fi Settings	Turning on or off WiFi Sta mode of the Taurus. When the Taurus is connected via external router, please turn on WiFi Sta mode, click the Wi-Fi name of the external router and then enter the password of the Wi-Fi.
	Wired Network Settings	Turning on or off DHCP. When the Taurus is connected via Ethernet cable, please turn off DHCP and set the static IP address and other relevant information.
	Mobile Data Settings	Turning on or off mobile data network. If the Taurus has 4G module, please turn on mobile network when the Taurus is connected via mobile data. Then information of the carrier is displayed on the page.
Monitoring	Ambient Brightness	Displaying ambient brightness. This is available only when the light sensor is connected to the Taurus series products.
	Temperature	Displaying receiving card temperature.
	Playback Screenshot	Capturing current screen.

Menu	Sub-Menu	Description
	System Parameter	Displaying CPU usage, available storage and external storage.
	Time Parameter	Displaying the time zone and time of the Taurus.
Video Control	-	<p>Controlling video input mode, video source, zoom and offset position. (For T6/TB6 and the later versions of Taurus only)</p> <p>Meanings of the values of Mode:</p> <ul style="list-style-type: none"> • Manual: Switch instantly between the synchronous mode and asynchronous mode. • Timing: Switch between the synchronous mode and asynchronous mode as scheduled. • HDMI preferred: HDMI is preferred for playing videos in synchronous mode. <p>Zoom is available for external HDMI input signal.</p> <p>Meanings of the values of Full screen:</p> <ul style="list-style-type: none"> • On: Images are scaled and displayed to fit the screen size automatically. • Off: Pictures are displayed according to the original size. <p>Prompt: Offset range cannot be greater than the screen width.</p>
Player Manager	-	<p>Reading back the solution played on the Taurus, playing or stopping, and deleting the solution.</p> <ul style="list-style-type: none"> • Solutions under Cloud Solution are sent to the Taurus from VNNOX. • Solutions under LAN Solution are sent to the Taurus from ViPlex Handy (iOS), ViPlex Handy (Android) and ViPlex Express.
Remote Management	VNNOX	<p>Binding asynchronous players of the VNNOX to the Taurus. After they are bound together, ViPlex Handy can download relevant solutions from VNNOX to Taurus.</p> <p>The values of User Name and Password are the same as the values on VNNOX.</p> <p>How to query:</p> <ol style="list-style-type: none"> 1. Log into VNNOX, Select System Management from the pop-up menu of  in the top right corner of the page. 2. Click Player Authentication tab to check

Menu	Sub-Menu	Description
		<p>Certified user name and Certified password.</p> <p>One asynchronous player can bind one Taurus only. Users can create new players or unbind the bound players.</p> <p>How to create:</p> <ol style="list-style-type: none"> 1. Log into VNNOX and click the  icon. 2. Click New. 3. Select Asynchronous player and click Next. 4. Set basic information of the player and then click OK. 5. Set attribute of the player and then click Save. <p>How to unbind:</p> <ol style="list-style-type: none"> 1. Log into VNNOX and click the  icon. 2. Select player information and click Attribute. 3. Click Status tab. 4. Click Remove Binding. 5. Click OK.
	NovaiCare	<p>Turning on or off remote monitor and registering screens on NovaiCare.</p> <p>Parameter meanings:</p> <ul style="list-style-type: none"> • Server: Specifying server of NovaiCare. • Possessor: Specifying username for logging into NovaiCare.
Screen Information	-	Displaying screen information, software version and sub-software version of the Taurus.

4.2 Multi-Screen Mosaic

Used for image mosaic by splicing multiple screens with the same specifications. Screens can only be spliced horizontally from the left to right.

Before You Begin

- Connect hardware devices. For example, splice 3 screens and use external video sources, as shown in [Figure 4-1](#).

- Log in to the corresponding Taurus units.

Figure 4-1 Taurus connection example

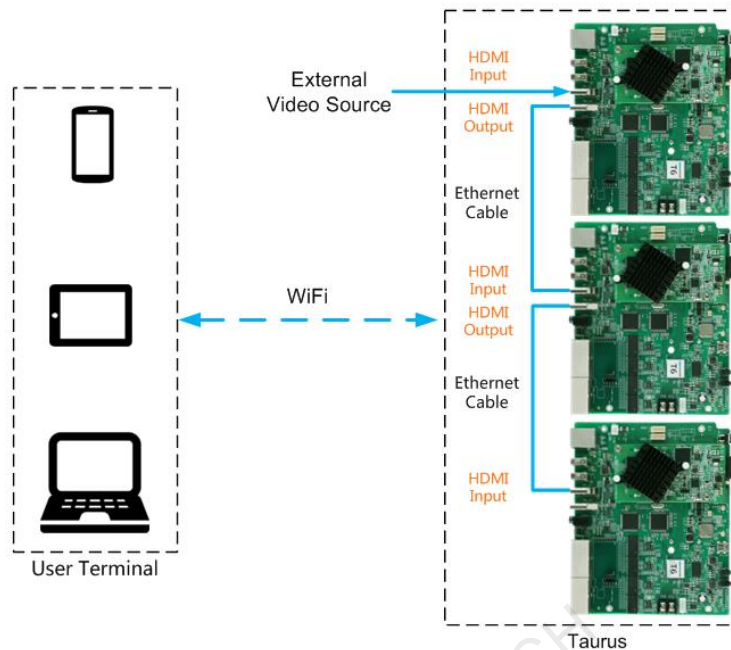

Setting Mosaic

Step 1 Enter a resolution and click **Query** to search for screens.

Step 2 Click **Mosaic**.

Step 3 Set the number of screens used for mosaic.

The number of screens cannot be greater than the ceiling integer of the value of "4096 / image width".

Step 4 Set mosaic orders.

The system will set the horizontal image offset automatically according to the mosaic orders and image width.

$$\text{Offset} = (\text{Mosaic order} - 1) \times \text{Image width}$$

For example, if the image width is 500 px, set the offset of the second screen to 500 px and the offset of the third screen to 1000 px.

Step 5 Set the video source of the first screen. If **HDMI** is selected, you have to turn off the full screen zoom function.

Canceling Mosaic

Click  to delete the mosaic orders of screens. The system will set the value of **X** to "0".

4.3 Solution List

Used for editing and publishing solutions and managing custom solution templates.

Note:

To make sure that ViPlex Handy can edit and publish solutions normally, users of the iOS 11.0 or later versions need to do the following settings.

- Photo setting: **Settings > Photos > Download and Keep Originals**
- Camera setting: **Settings > Camera > Formats > Most Compatible**

ViPlex Handy supports media types in [Table 4-1](#).

Table 4-1 Media types

Menu name	Format
Image	<p>Adding pictures, and setting the display effects, play duration and transition of the images. When you add images, you can crop them.</p> <p>Images can be added through the following two methods:</p> <ul style="list-style-type: none"> • Add pictures from the local media library. • Add pictures through the camera. (Android only) <p>Supported formats: JPEG, BMP, GIF, PNG, WEBP.</p>
Video	<p>Adding videos, and setting the display effects of the videos.</p> <p>Supported formats: MPEG-1/2, MPEG-4, H.264/AVC, MVC, H.265/HEVC, Google VP8, H.263, VC-1, Motion JPEG</p> <p>For Android version, also supports adding images of GIF format.</p> <p>For Android, GIF images also can be added.</p>
GIF (iOS only)	Adding images of GIF format.
Text	Adding single-line or multi-line texts, and setting the text properties, play duration and transition of the texts.
Clock	Adding analog clocks, and setting the styles, texts and play duration of the analog clocks.
Weather (Android only)	Adding weather widgets, and setting the display content, temperature unit and animation effects, etc.
Digital clock	Adding digital clocks, and setting the styles and play duration of the digital clocks.

4.4 Settings

Menu	Description
Help	Displaying software version, copyright information, email address

Menu	Description
	and providing the link of User Guide.
Language	Setting software language.
Message (Android only)	Displaying push messages and notifications from system.

4.5 Media

Used for displaying local media on a mobile phone.

XI'AN NOVASTAR TECH CO.,LTD

5 FAQ

5.1 Viewing the Version of ViPlex Handy

Question

How to view the version of the ViPlex Handy?

Answer

Step 1 Choose **System Settings > Help**.

Step 2 View the version of the ViPlex Handy.

5.2 Viewing the Version of the Taurus

Question

How to view the version of the Taurus?

Answer

Step 1 Log in to the Taurus.

Step 2 Click the screen name and enter the **Screen Management** page.

Step 3 Select **Screen Information**.

Step 4 View the version information and sub-software version information of the Taurus.

5.3 Upgrading the Version of the Taurus

Question

How to upgrade the version of the Taurus?

Answer

Only Android supports software version upgrade.

Step 1 Log in to the Taurus.

Step 2 Click the screen name and enter the **Screen Management** page.

Step 3 Choose **Advanced Settings > Upgrade**.

Step 4 Click **Upgrade** next to the target version.

XI'AN NOVASTAR TECH CO.,LTD